

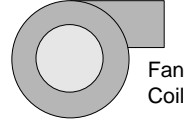

Outdoor temperature sensor

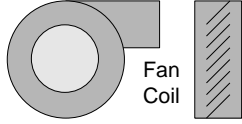

Fan Coil



Fan Coil

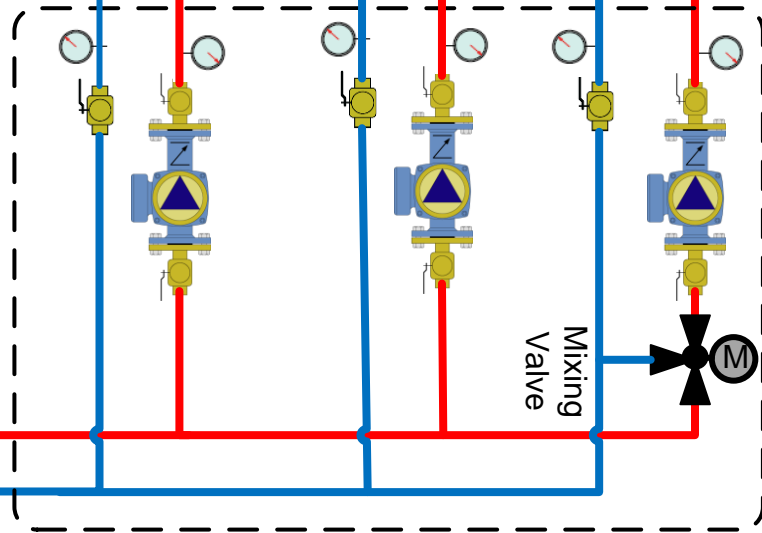
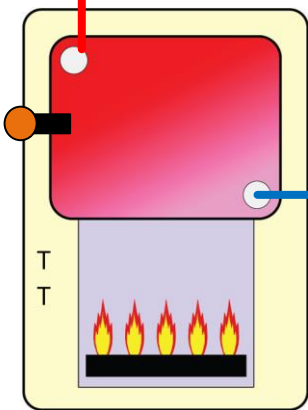
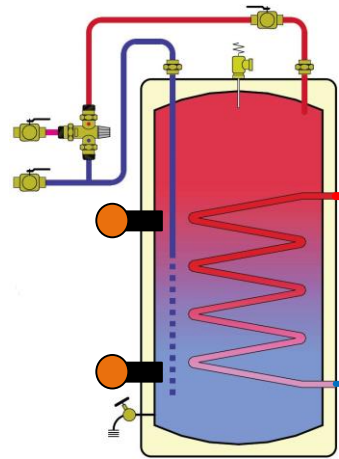

Mixing Valve

ITEM	QTY.	PART NO.	DESCRIPTION
------	------	----------	-------------

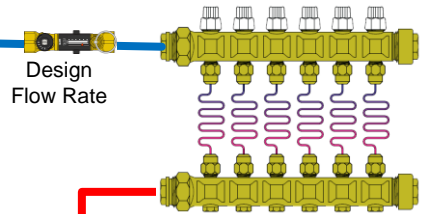
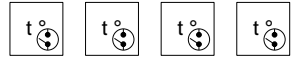
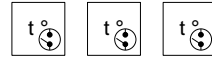

Design Flow Rate

First Floor

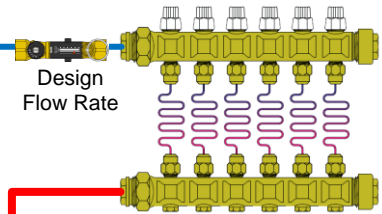

Design Flow Rate

Second Floor

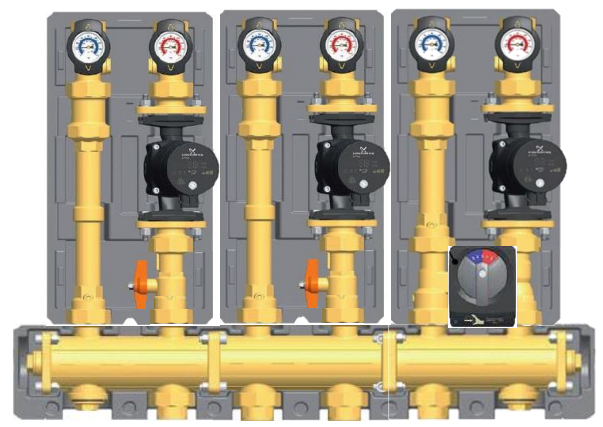

DRAWN	LY
ISSUED	Feb-22/2018

SIZE	FSCM NO	DWG NO	REV
		3 Zones/ 1 Radiant, 1 Fan Coil & 1 DHW	
SCALE	NTS	SHEET	1 OF 1