

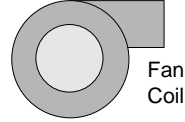

Outdoor temperature sensor

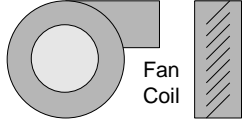

Fan Coil



Fan Coil

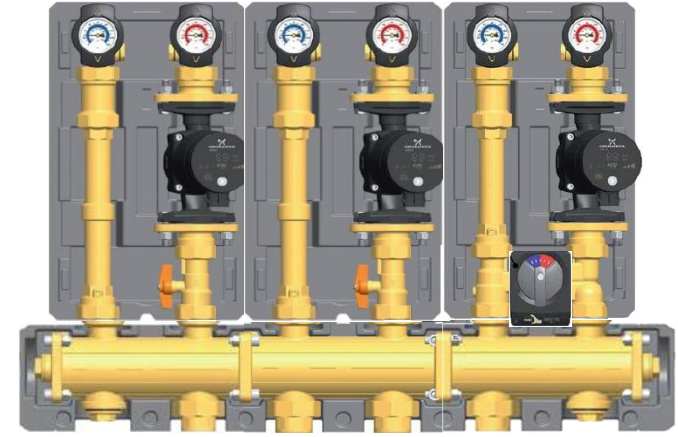
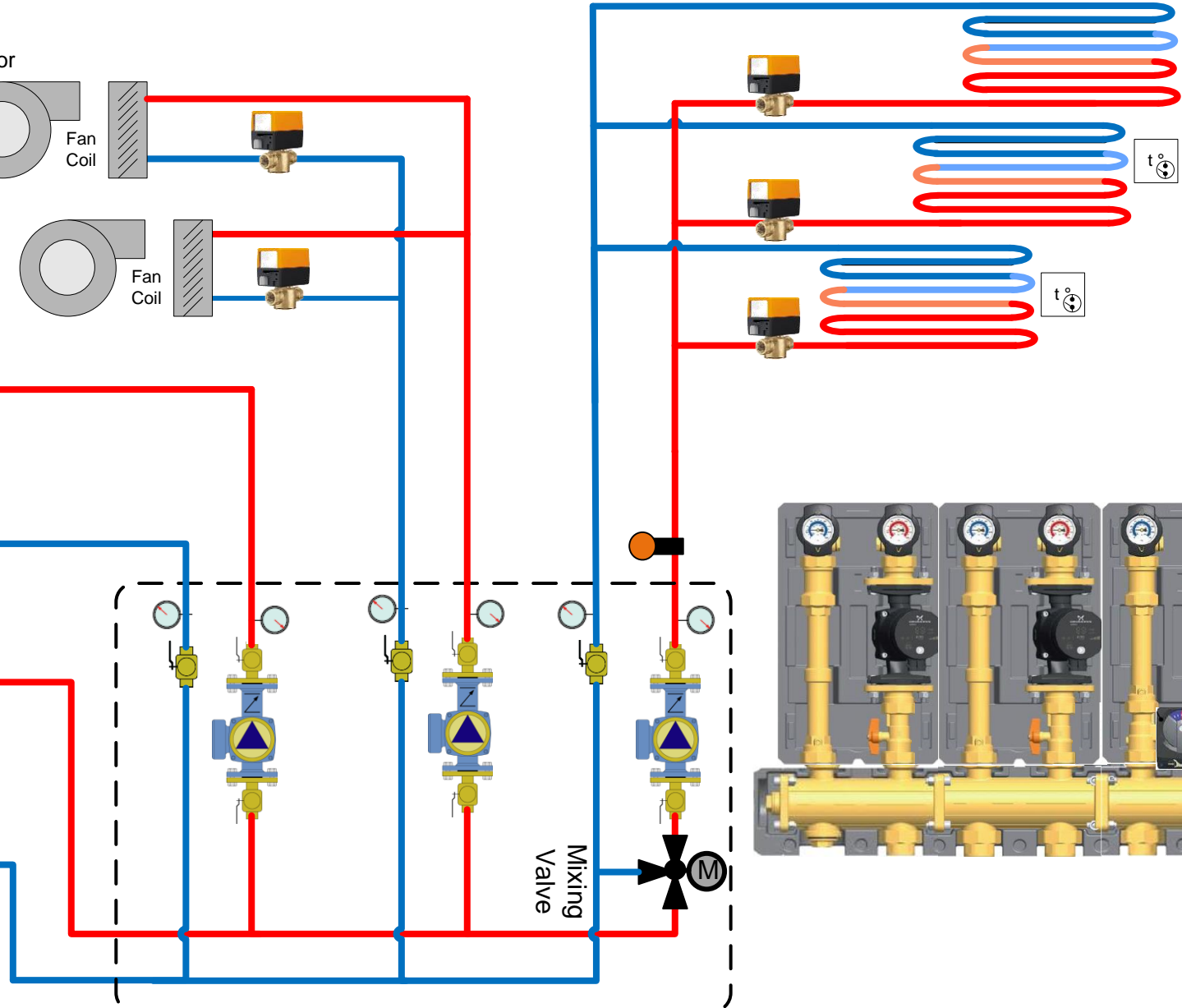
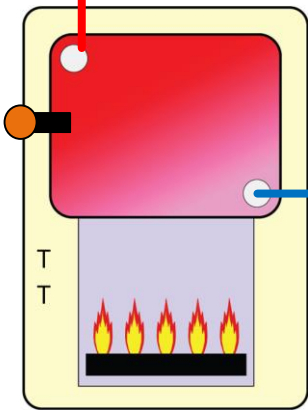
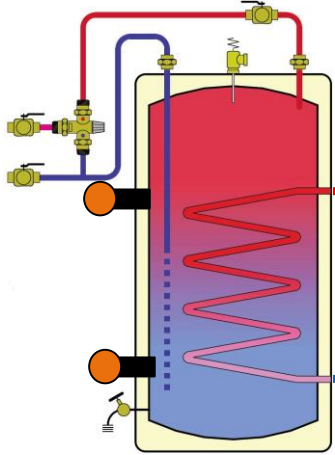

ITEM	QTY.	PART NO.	DESCRIPTION
------	------	----------	-------------

			t°
			t°
			t°

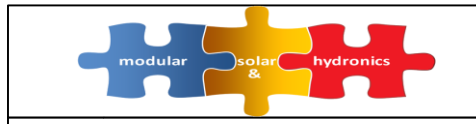

DRAWN L.Y

ISSUED Feb-20/2018

SIZE FSCM NO

SCALE NTS

DWG NO
3 Zones/ 1 Radiant, 1 Fan Coil & 1 DHW

REV

SHEET 1 OF 2



Outdoor temperature sensor

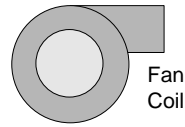

Fan Coil

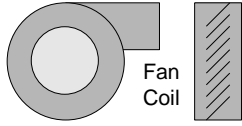

Fan Coil

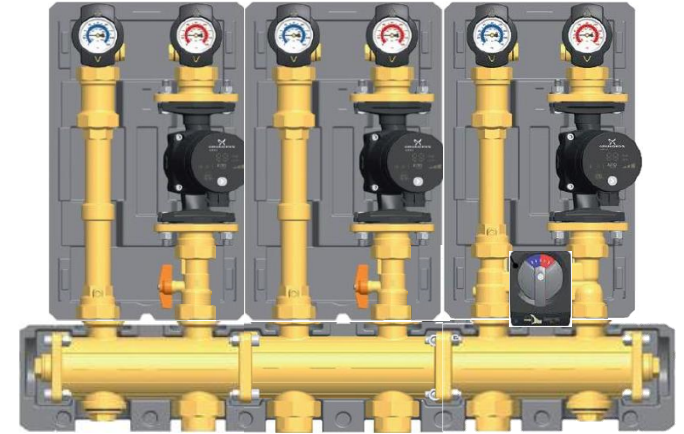
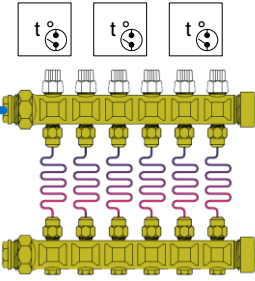
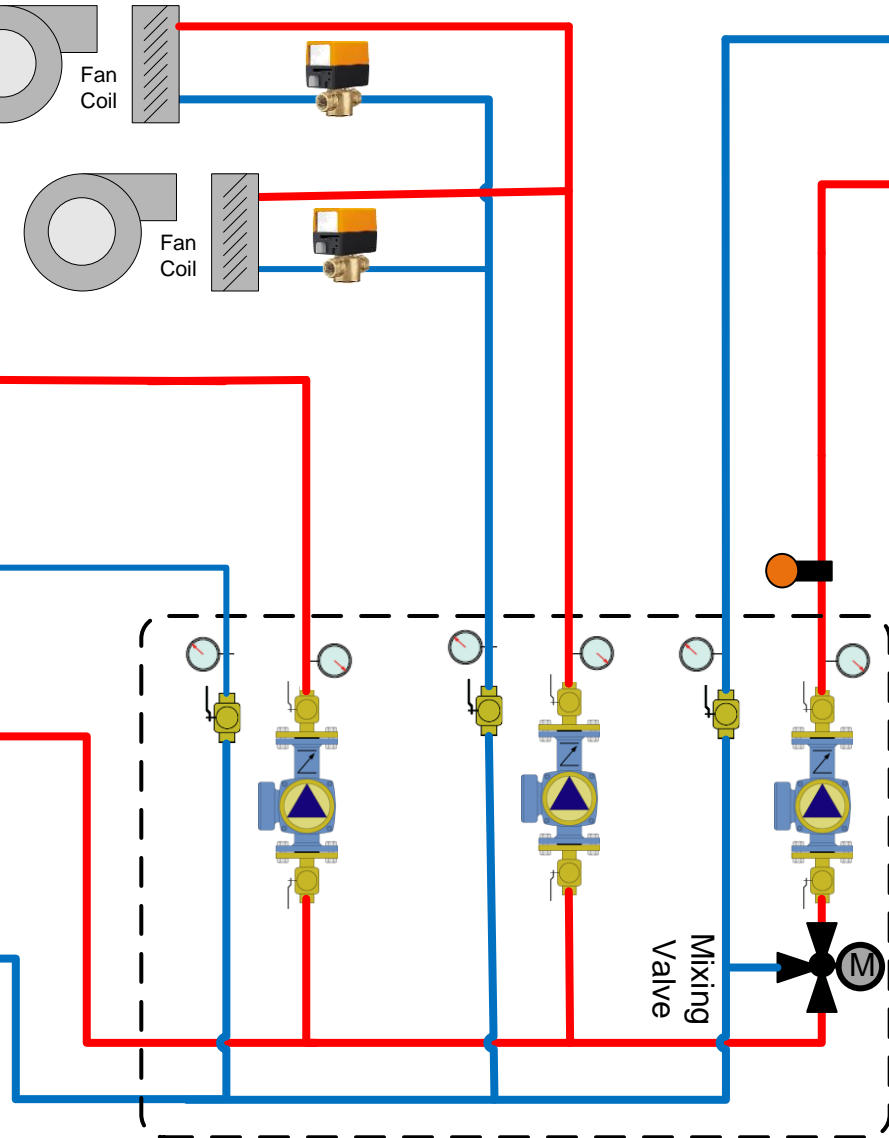
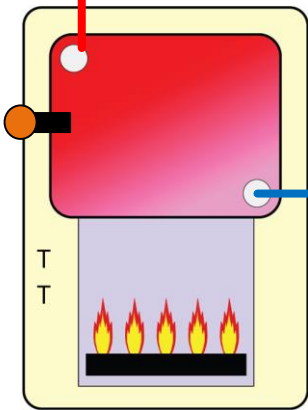
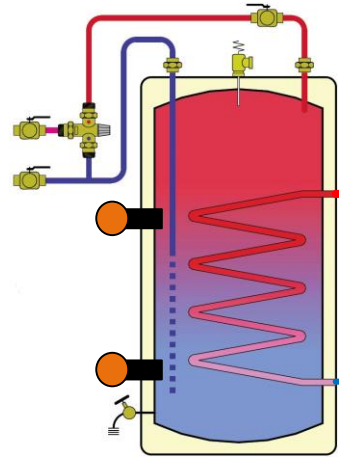

ITEM	QTY.	PART NO.	DESCRIPTION
------	------	----------	-------------



DRAWN	L.Y
ISSUED	Feb-20/2018

SIZE	FSCM NO
SCALE	NTS

DWG NO	REV
3 Zones/ 1 Radiant, 1 Fan Coil & 1 DHW	
SHEET	2 OF 2