

$t_{\text{e}}$   $t_{\text{e}}$   $t_{\text{e}}$   $t_{\text{e}}$   $t_{\text{e}}$  Room  
 Thermostat

 Outdoor  
 temperature sensor

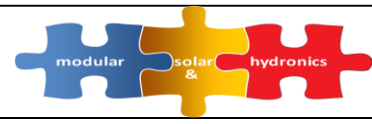

ITEM	QTY.	PART NO.	DESCRIPTION
------	------	----------	-------------

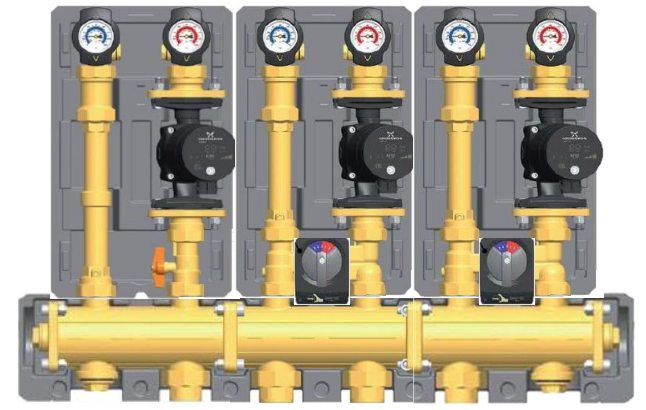
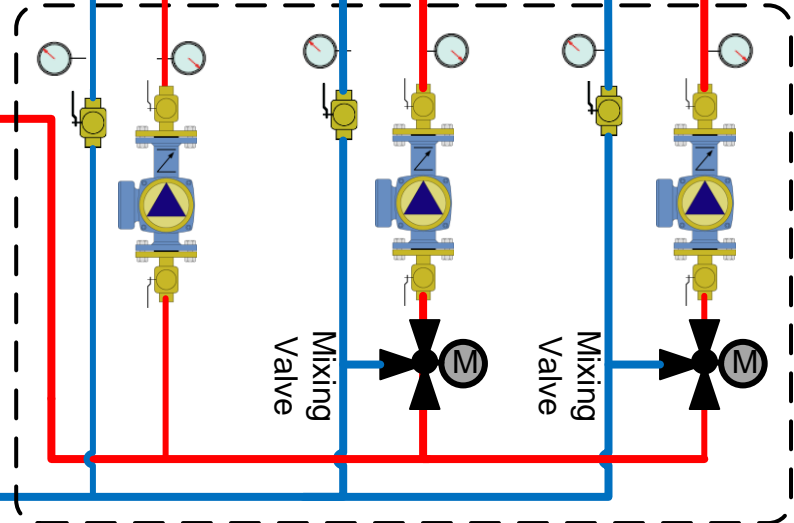
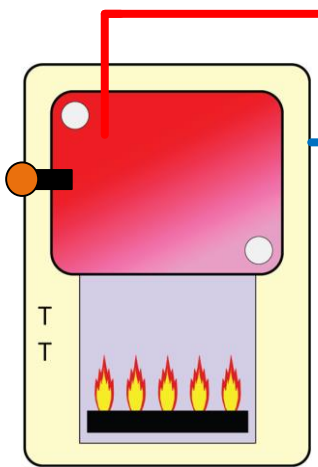
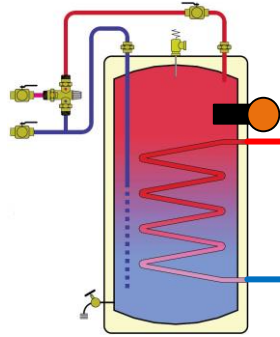
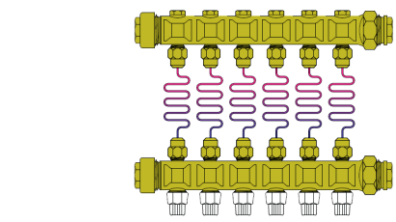
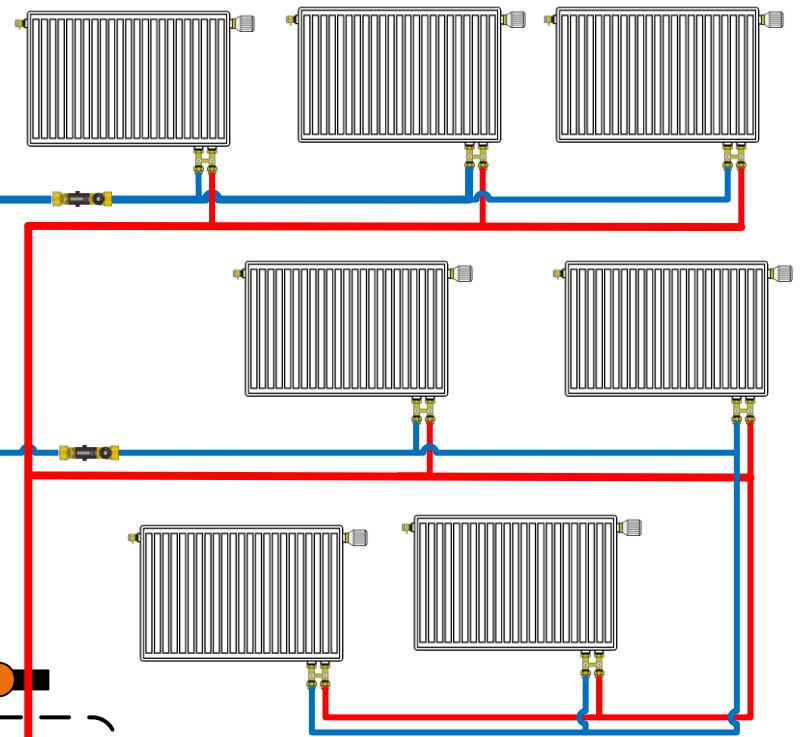

DRAWN	LY
ISSUED	Feb-27/2018

SIZE	FSCM NO
SCALE	NTS

DWG NO	REV
3 Zones/1 Radiant, 1 Radiator 1 DHW	
SHEET	1 OF 1